

Rotary Evaporator

Highly efficient standard rotary evaporator with manual lift



RE202-A/212-A (*basic*) REV202M-A/212M-A (*with vacuum controller*)

Evaporating / receiving flask

100 ml to 2L / 1L (Standard)

Rotation speed control range

5~315 rpm

Water bath / oil bath temp. range

RT +10~90°C / RT +10~180°C

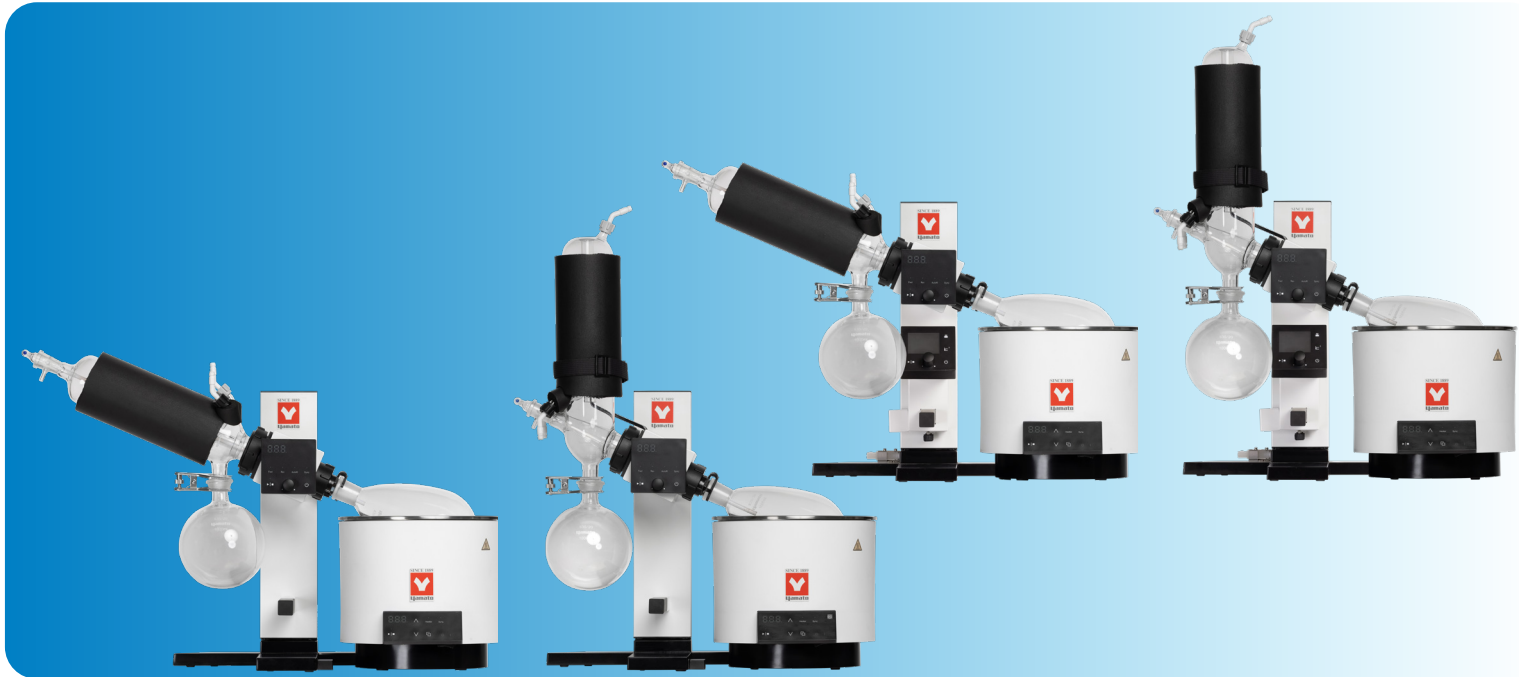

Features

● 5 ~ 315 rpm rotation speed range

Turning the encoder dial slowly increases or decreases the value by 1, turning it quickly changes the value by 10.

Selectable rotation mode (forward, reverse, auto reverse)

RPM display brightness can be adjusted in 8 levels.



● Set inversion function

Glassware and bath can be set in either side, left or right, depending on user's dominant hand and installation location.

Three units of Glassware B (with vertical condenser) can be installed in a standard fume hood.



● Uniquely designed glass condenser

This prevents liquid stagnation and backflow improving durability of vacuum seal

When using ketone or ether solvents, standard vacuum seal swells. It is recommended to use PTFE vacuum seal.

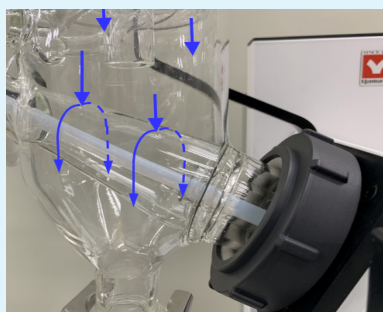

● Two types of baths

Option for water and oil bath.

Large capacity 5L bath with 240mm I.D. and a full complement of safety functions such as automatic overheat prevention and temp. upper limit difference.



Specifications

Model		MODELS WITHOUT VACUUM CONTROLLER		
		RE202-AWA / 212-AWA (Glassware A)	RE202-BWA /212-BWA (Glassware B)	RE202-CWA / 212-CWA (Glassware C)
Performance *1	Operating ambient temp. range	5~35°C		
	Speed range	5~315 rpm *3		
	Evaporation capacity	Up to 23 ml/min		
Functions	RPM display	Digital display / Control knob		
	Rotation mode	Forward / Reverse / Auto inversion		
	Spring-loaded jack	Manual balance (maximum height 200 mm, stepless regulation, one-touch lock)		
Configuration	Rotary motor	DC brushless (simple servo)		
	Condenser retention	---	Condenser bracket	
Safety functions	Rotary evaporator	DC motor: Motor overload protection, overvoltage, low voltage, rotation speed sensor error AC adapter: Short circuit in internal circuit, overcurrent protection, overvoltage protection		
Standard	Cooling condenser	Double corrugated tube (cooling surface: 0.143 m ²)		
		Suction port: GL-14 (lower), Φ10 nozzle	Suction Port: GL-14 (upper), Φ10 nozzle	
		Cooling port: GL 14 (two places in lower part), two φ10 nozzles	NA	
	Compatible evaporation flask	50-2000 ml. Use optional reducer to attach small flasks		
	Compatible receiving flask	100-2000 ml		
	External dimensions *2	W719 × D24 × H534	W529 × D324 × H745	W529 × D324 × H745
	Overall dimensions *2 (including bath) (W x D x H)	744 × 365 × 534	554 × 365 × 745	554 × 365 × 745
	Weight	~10.0 kg		
Included accessories	Power rating 50/60Hz	RE202: 100-115V 1A with plug RE212: 200-230V single phase 1A no plug, round terminal		
		Main unit: AC adapter (1), power cable (1), bath guide (1), rear cover (1), single-sided tape fastener roll (1), double-sided tape fastener roll (1) Glass set: Cooling condenser (type A/B/C)(1), rotary joint (1), evaporation flask (1), receiving flask (1), ball joint clamp (1), flask clip (1), vacuum seal (1), condenser insulation kit (1), condenser bracket (1) (for type B/C), hex wrench (1) (for type B/C)		

Model		MODELS WITH VACUUM CONTROLLER		
		REV202M-AWA / 212M-AWA (Glassware A)	REV202M-BWA / 212M-BWA (Glassware B)	REV202M-CWA / 212M-CWA (Glassware C)
Performance *1	Operating ambient temp. range	5~35°C		
	Speed range	5~315 rpm *3		
	Evaporation capacity	Up to 23 ml/min		
	Pressure setting range	0-1013 hPa		
Functions	RPM display	Digital display / Control knob		
	Rotation mode	Forward / Reverse / Auto inversion		
	Spring-loaded jack	Manual balance (maximum height 200 mm, stepless regulation, one-touch lock)		
Configuration	Vacuum controller	VR102S, installed above jack handle with attachment bracket		
	Vacuum control solenoid valve	OVR10, installed in the rear of stand base		
	Rotary motor	DC brushless (simple servo)		
	Condenser retention	---	Condenser bracket	
Safety functions	Rotary evaporator	DC motor: Motor overload protection, overvoltage, low voltage, rotation speed sensor error AC adapter: Short circuit in internal circuit, overcurrent protection, overvoltage protection		
	Vacuum controller	Communication error, Pressure sensor error, Memory error, Leak error, High pressure error, Auto leak at error occurrence		
Standard	Cooling condenser	Double corrugated tube (cooling surface: 0.143 m ²)		
		Suction port: GL-14 (lower), Φ10 nozzle	Suction Port: GL-14 (upper), Φ10 nozzle	Suction Port: GL-14 (upper), Φ10 nozzle
		Cooling port: GL 14 (two places in lower part), two φ10 nozzles	NA	
	Compatible evaporation flask	50-2000ml. Use optional reducer to attach small flasks		
	Compatible receiving flask	100-2000 ml		
	External dimensions *2	W719 × D24 × H534	W529 × D324 × H745	W529 × D324 × H745
	Overall dimensions *2 (including bath) (W x D x H)	744 × 365 × 534	554 × 365 × 745	554 × 365 × 745
Weight	~10.5 kg			
Included accessories	Power rating 50/60Hz	REV202M: 100-115V 1A with plug REV212M: 200-230V single phase 1A no plug, round terminal		
		Main unit: AC adapter (1), power cable (1), bath guide (1), rear cover (1), single-sided tape fastener roll (1), double-sided tape fastener roll (1) Glass set: Cooling condenser (type A/B/C)(1), rotary joint (1), evaporation flask (1), receiving flask (1), ball joint clamp (1), flask clip (1), vacuum seal (1), condenser insulation kit (1), condenser bracket (1) (for type B/C), hex wrench (1) (for type B/C)		

*1 Performance data above based on 23 ±5 °C room temperature, 65%RH ±20% humidity, and no process load.

*2 Dimensions excludes protrusions.

*3 Applicable rotation speed range and sample volume depend on the capacity of evaporation flask.

Operational Accessories

Glassware Set

Product code	Set
RG202A	Set A (use with chiller) Traditional glass set where condenser is tilted diagonally
RG202B	Set B (use with chiller) Standard glass set where condenser is set vertically, suitable for limited space
RGB202C	Set C (cold finger) The cold finger glass condenser is set vertically, suitable for distillation of volatile or low boiling point solvents.

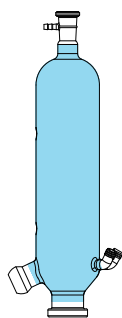

Condenser A

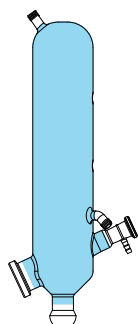

Condenser B

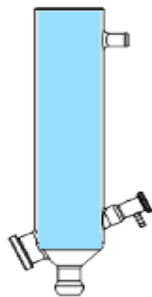

Condenser C

Vacuum Controller



- Equipped with a color LCD that allows you to judge the operating status by color. Suppresses bumping with three operation modes that can be selected according to application.
- Evaporator body and vacuum pump work together with one button
- Wireless connection with specified vacuum pumps for control

Bath Specifications

Product name	Water bath		Oil bath	
	Model	BM302-A	BM312-A	BO302-A
Temp. control range *1	RT +10°C~90°C		RT +10°C~180°C	
Temp. control accuracy *1	±1.0°C		±1.5°C (water), ±2°C (oil)	
Safety features	Automatic overheat prevention, independent overheat prevention (fixed temp.), temperature upper limit error, overcurrent protection fuse			
Other features	Calibration offset, overshoot alert, auto resume (selectable), 2A service outlet (for AC100~115V)			
Bath capacity	~5L			
Internal dimensions	Φ240 x H119 mm			
External dimensions *2	Φ262(max depth 286mm) x H240 mm			
Weight	~4.5kg			
Power supply (fuse capacity)	AC100~115V 10~12A (15A)	AC200~230V 5~6A (10A)	AC100~115V 10~12A (15A)	AC200~230V 5~6A (10A)

*1 Performance data above based on 220 VAC ±5% supplied power, 23 ±5 °C ambient, 65%RH. ±20% humidity, and no process load. Temp accuracy measured in JTM K05.

*2 Dimensions excludes protrusions.



REV-202M-CWA

Rotary Evaporator Set with Vacuum Controller and Condenser C

Model	VR102S
Setting range of the degree of vacuum*1	0 to 1013 hPa
Measurement range of the degree of vacuum	0 to 1100 hPa
Display	Color LCD (2.3")
Display items	Measurement/setting of vacuum degree, operation time, status
Operation mode	Manual (constant operation), Gradient (gradient decompression, constant operation) Auto (gradient decompression, target pressure automatic setting)
Hold function	Maintains current vacuum degree in the middle of decompression (controlled)
Pressure unit	mmHg/Torr/hPa/kPa/mbar
Automatic functions at end of operation	Auto leak, Auto cleaning
Vacuum control system*2	Based on ON/OFF of vacuum control solenoid valve, or pump rotation speed.
Safety functions	Communication error, pressure sensor error, memory error, leak error, high pressure error, auto leak at error occurrence
External dimension*3	86AW x 113D x 83H
Power supply	24V DC *1 (100-240VAC 1A or less)
Weight	0.5 kg
Included accessories	Vacuum line branch joint (O.D. φ4 x φ2 x 700 mm with PTFE tube)

*1 A separate optional vacuum control solenoid valve is required. With the combination of vacuum pump N820G and vacuum pump control unit G, vacuum control can be performed by pump rotation speed without vacuum control solenoid valve. However, operation mode is limited.

*2 An optional connection cable (multi line of power supply/operation signal) for connecting RE unit is required. When using this unit without connecting to RE units, use optional AC adapter/power cable separately.

*3 Dimensions excludes protrusions.

Optional Accessories

Glassware



Evaporating flask
Size: 24/40

Receiving flask
Size 35/20

Product code	Capacity	Product code	Capacity
255713	2L	255719	2L
255712	1L*	255718	1L*
255711	500ml	255717	500ml
255710	300ml	255716	300ml
255709	200ml	255715	200ml
255708	100ml	255714	100ml

Size: 29/38

Product code	Capacity
255706	2L
255705	1L
255704	500ml
255703	300ml
255702	200ml
255701	100ml

*Standard



Three-way cock

Product code	Description
255738	Used for switching receiving flasks during operation S35/20 male/female. Length 114 mm



Lab jack

Product code	Description
255745	150 x 150 mm Height 75 - 245 mm
255746	200 x 200 mm Height 75 - 245 mm



Rotary joint
RG202A

Product code	Size	Type
255720	29/38 L284mm	Standard
255722	24/40 L286mm	Standard*
255724	29/38 L284mm	Transparent
255726	24/40 L286mm	Transparent

RG202B and RGB202C

Product code	Size	Type
255721	29/38 L208mm	Standard
255723	24/40 L210mm	Standard*
255725	29/38 L208mm	Transparent
255727	24/40 L210mm	Transparent



Product code	Description
255738	Sample feed stopcock



Condenser insulation kit

Product code	Description
RG02AS0000	Condenser A and B only



Rotary joint different diameter

Product code	Description
255732	24/40 → 24/40 L105mm
255733	24/40 → 19/38 L103mm
255734	24/40 → 15/25 L90mm
255728	29/38 → 29/38 L106mm
255729	29/38 → 24/40 L108mm
255731	29/38 → 15/25 L105mm
255730	29/38 → 19/38 L105mm



Vacuum nozzle (gray)

Product code	Description
255512	GL14 K10 mm O.D. 2 pcs



Cooling nozzle (black)

Product code	Description
255742	GL14 K10 mm O.D. 2 pcs

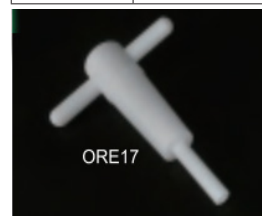

Stop cock

Product code	Material
255735	PTFE, 19/38

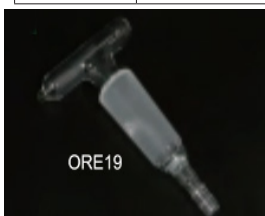

Stop cock

Product code	Material
255736	Glass, 19/38



Ball trap

Product code	Measurement
LG1910270055	24/40 → 24/40



FKM vacuum seal

Product code	Description
255740	Standard



PTFE vacuum seal

Product code	Description
255741	Recommended for ketone and other solvents

Optional Accessories

Water Circulator (Chiller)

CF303Y/CF313Y

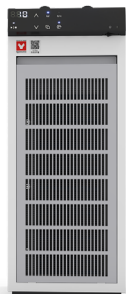

Model	CF303Y / CF313Y	CF802A
Operating temp. range	-20°C~30°C	
Temp. control accuracy	±1.0°C (≥ 0°C) ±1.5°C (< 0°C)	±1.0°C
Cooling capacity	~450W at liquid temp 10°C ~330W at liquid temp -10°C	~1320W (at 10°C) ~700W (at -10°C)
Temp. control	Refrigerator On/Off	
Refrigerator, coolant	Air cooling 450W, R452A	Air cooling, 700W, R410A
External dimension WxDxH (including protrusions)	205 × 396 × 535 mm (225 × 434 × 564 mm)	340 × 370 × 838 mm (340 × 408 × 920 mm)
Water capacity	~3.9L (Liquid volume 3.5L)	~15.5L (liquid volume 14L)
Power source 60Hz	115V 6.8A / 220V 4A	Single phase 115V 15A
Weight	~30kg	~44kg

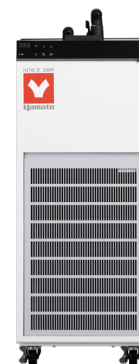

CF802A

Control panel



Filter mounting plate



Circulation hose connection



Discharge and Return Ports



Vacuum Pump



Model	255161 (N820G)
Ultimate vacuum (mbar abs.)	
Minimum speed:	
Gas ballast closed	≤ 6
Gas ballast open	≤ 17
Maximum speed:	
Gas ballast closed	≤ 8
Gas ballast open	≤ 15
Flow rate at atm. pressure (l/min)	
Min. speed	9
Max. speed	20
Permissible ambient temperature	+10°C to + 40°C
Diaphragm material	PTFE-coated
Voltage (V)	100-240
Frequency (Hz)	50/60
Max. operating current (A)	0.66
Dimensions LxWxH (mm)	259 x 163 x 220
Weight (kg)	8.8

Vacuum Control Solenoid Valve

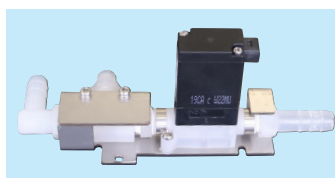

255762 (OVR10)

- Opens / closes to control the degree of vacuum
- Works with VR102S Vacuum Controller by wire
- Can be installed onto RT302 solvent recovery unit

Included accessories:

- PTFE tube $\phi 4 \times \phi 2 \times 700$ mm 1 pc
- Solenoid valve cable 1 pc

Vacuum Pump Control Unit G



255783 (OVR26)

- Regulates motor speed of vacuum pump to control the degree of vacuum
- Wireless interconnection with VR102S

Included accessories:

- N820G mounting bracket 1 pc.
- Hexagon wrench 1 pc.
- M4 hexagon socket head cap screw 3 pcs.

Compatible pump:

Yamato Scientific N820G

Stand



255770 (ORT10)

- Stand for VR102S and vacuum pump
- Power supply to this unit is either RE connection cable or AC adapter
- Includes waste liquid trap bottle (250 ml) 255772 (ORT14)

Exhaust Trap Kit



255771 (ORT12)

- Used as a solvent recovery unit by installing onto ORT10 stand.
- Comes with an exhaust trap, 500 ml flask, tray, connection hose on the OUT side, and a set of attachment brackets

Solvent Recovery Unit



RT302 (255378)

- Allows efficient solvent recovery by cooling water circulation
- Connected to the exhaust side of a diaphragm vacuum pump
- Combination of stand (255770) and exhaust trap kit (255771)

Optional Accessories

Bath Protection Cover

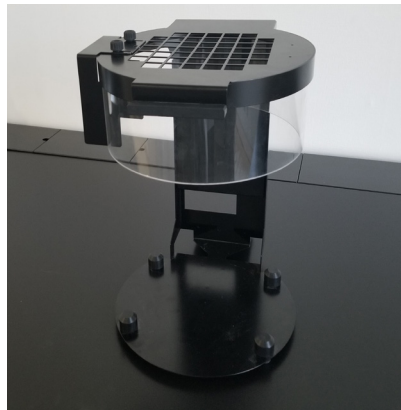

Product Code	BC102
Material for main body (base & lid)	SUS304
Material for cover	Acrylic
Dimensions	W265 x H365 x D369 mm (including protrusions)
Weight	5 kg
Power source	No power required
Included accessories	Knurled screws x 2, entanglement prevention plate x 1
Compatible models	BM302A/312A, BO302A/312A

- Prevents possible damage from water and oil droplets due to high speed rotation
- Prevents clothing, neck straps, etc. from getting caught during operation



Installed with REV-202MA and BM water bath or BO oil bath



Open bath cover

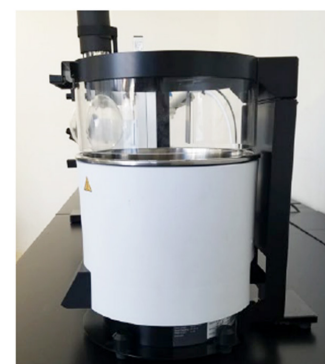

Closed bath cover

Vacuum Pressure Controller (alternative option)

Specifically built to work in chemically harsh environments to reliably maintain pressures for low temperature distillation

- Fine grained vacuum control
- Simultaneous display of both current vacuum and set point
- Direct one-touch set point setting
- Remote control via USB



Gauge and front display



Rear connectors

Product Code	DIG-VPC
Vacuum reference	Absolute
Sensor	SEN-775i-NPT-OEM
Resolution	+/- 0.1 Torr
Units	Torr, mbar
Accuracy	+/- 2.66 mbar; +/- 2 Torr
Range	1 – 1013 mbar; 1-775 Torr
Control band	+/- 2.66 mbar; +/- 2 Torr
Mount	Desktop or laboratory pole mount
Display	0.56 inch white LED for pressure, 0.36 inch blue LED for set point
External dimensions	W4.5" x H3.375" x D6.25"
Power	110V standard receptacle / 220V three pronged
Compliance	CE and RoHS compliant
Wetted materials	316 SS, chemically resistant rubber, PTFE
Effective orifice	0.150 in
Connectivity	USB
Vacuum interface	3/8" I.D. hose barbs, 1/4" NPT F
LED heights	.56" / .35"

Set Guide

Set Combination

STANDARD SET

MAIN UNIT + BATH + GLASSWARE SET

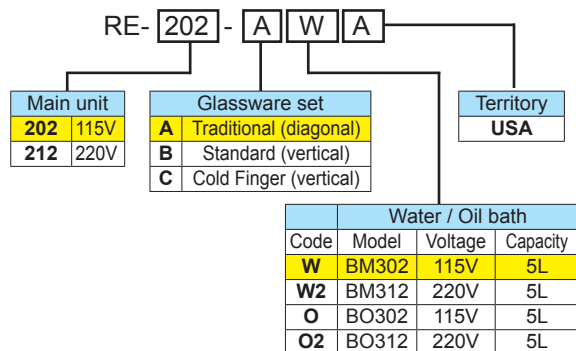

SET WITH VACUUM CONTROLLER

MAIN UNIT + VACUUM CONTROLLER + BATH + GLASSWARE SET

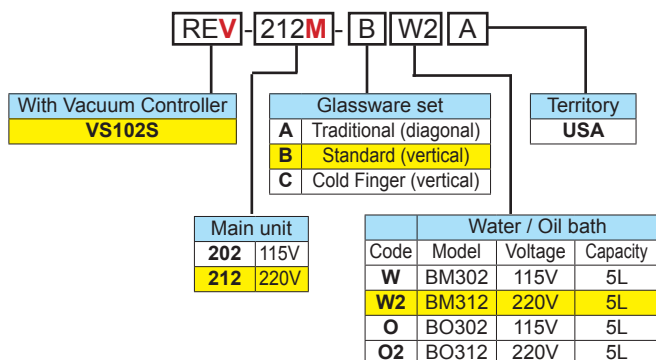

Basic Set Selection Chart

Model	Glassware			Water Bath		Oil Bath		Vacuum Controller
	A	B	C	BM302	BM312	BO302	BO312	
RE-202-AWA	●			●				
RE-202-BWA		●		●				
RE-202-CWA			●	●				
RE-202-AOA	●					●		
RE-202-BOA		●				●		
RE-202-COA			●			●		
RE-212-AW2A	●				●			
RE-212-BW2A		●			●			
RE-212-CW2A			●		●			
RE-212-AO2A	●						●	
RE-212-BO2A		●					●	
RE-212-CO2A			●				●	
REV-202M-AWA	●			●				●
REV-202M-BWA		●		●				●
REV-202M-CWA			●	●				●
REV-202M-AOA	●					●		●
REV-202M-BOA		●				●		●
REV-202M-COA			●			●		●
REV-212M-AW2A	●				●			●
REV-212M-BW2A		●			●			●
REV-212M-CW2A			●		●			●
REV-212M-AO2A	●						●	●
REV-212M-BO2A		●					●	●
REV-212M-CO2A			●				●	●

Set Variation

SET 1 FOUNDATIONAL SET

Includes a space-saving glassware set B (vertical condenser) and water bath. Also available in glassware set A (diagonal condenser) and glassware set C (cold finger diagonal condenser)



Product code	RE-202-BWA
RE202	Rotary evaporator
RG202B	Glassware set B (vertical condenser)
BM302A	Water bath

SET 2 BASIC SET

Includes a space-saving glassware set B (vertical condenser), water bath and vacuum pump.



Product code	RE-202-BWA-BSC
RE202	Rotary evaporator
RG202B	Glassware set B (vertical condenser)
BM302A	Water bath
N820GKIT	Diaphragm vacuum pump & hose

SET 3 STANDARD SET

Includes a space-saving glassware set A (diagonal condenser), water circulator (chiller), water bath and vacuum pump.



Product code	RE-202-AWA-STD
RE202	Rotary evaporator
RG202A	Glassware set A (diagonal condenser)
BM302A	Water bath
CF303Y	Water circulator (chiller)
221581	Insulation hose 2 pcs.
N820GKIT	Diaphragm vacuum pump & hose

SET VARIATION

SET 4 COMPLETE SET 1

Similar to Set 3 (glassware set B, water circulator, water bath and vacuum pump) but with the addition of a **vacuum controller** and a **trap bottle**. User friendly and space saving.

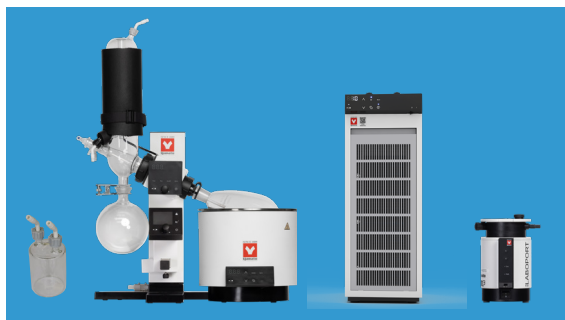

Product code	REV-202M-BWA-CMPT
REV202M	Rotary evaporator with vacuum controller
RG202B	Glassware set B (vertical condenser)
BM302A	Water bath
CF303Y	Water circulator (chiller)
221581	Insulation hose 2 pcs.
N820GKIT	Diaphragm vacuum pump & hose
255783	Vacuum pump control unit G (OVR26)
YS22Z0020	Water liquid trap bottle

SET 5 COMPLETE SET 2

Similar to Set 4, this comes with a rotavap with vacuum controller, glassware B, chiller, water bath and vacuum pump. In addition, it considers environment protection and odor measures by improving collection efficiency through a **secondary trap**.



Product code	
REV202M	Rotary evaporator with vacuum controller
RG202B	Glassware set B (vertical condenser)
BM302A	Water bath
255770	Stand (ORT10)
255771	Exhaust trap kit (ORT12)
CF303Y	Water circulator (chiller)
221581	Insulation hose 2 pcs.
281330	Insulation hose (OA094) 1 pc.
N820GKIT	Diaphragm vacuum pump & hose
255783	Vacuum pump control unit G (OVR26)

SET 6 "USE YOUR OWN VACUUM PUMP" SET

A complete set with a rotavap with vacuum controller, space-saving glassware set B (vertical condenser), water circulator (chiller) and water bath, combined with your **existing vacuum pump**. Vacuum pump is manually and continuously operated.



Product code	
REV202M	Rotary evaporator with vacuum controller
RG202B	Glassware set B (vertical condenser)
BM302A	Water bath
CF303Y	Water circulator (chiller)
221581	Insulation hose 2 pcs.

SET 7 DOUBLE PERFORMANCE SET

A combination that connects two complete sets of rotary evaporator (glassware set B, water bath and vacuum pump) with one water circulator (CF802) that can be installed under the laboratory table or fume hood, and a secondary trap.



Product code	Qty	
REV202M	2	Rotary evaporator with vacuum controller
RG202B	2	Glassware set B (vertical condenser)
BM302A	2	Water bath
CF802A	1	Water circulator (chiller)
281478	1	Secondary trap (OCF84)
221581	2 sets	Insulation hose 2 pcs.
N820GKIT	2	Diaphragm vacuum pump & hose
255783	2	Vacuum pump control unit G (OVR26)